

Colour Observation Camera

Table of contents

	Page
Introduction	4
Connection and operation facilities	5
Installation	5
Camera position	
Focus adjustment	
Back-focus adjustment	
Camera sound on/off	
Outdoor use	
Using a different lens	9
System cable	10
Tips for maintenance	10

Introduction

This camera is especially designed for the colour Philips Observation Systems. It combines a high sensitivity sensor with advanced digital signal processing, resulting in a high quality camera with excellent performance under even difficult circumstances. The camera has a standard camera mount allowing installation on, for example, a tripod or wall bracket.

Camera accessories:

The following camera accessories are available:

- Protective camera housing for protection against dust and theft
- Weather proof housing for outside use
- Extension system cables
- Mains power adapter for providing additional power to the camera at large distances

Read these instructions, before taking your system in operation.

Connection and operation facilities

- 1 Focus adjustment ring
- 2 Back-focus adjustment ring

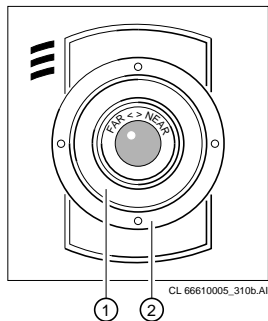

- 3 Camera sound on/off
- 4 Auto-iris socket
- 5 Cable length compensation selector
- 6 System cable socket
- 7 External supply socket

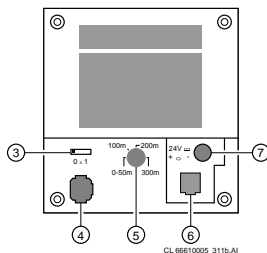

Installation

This chapter describes the installation of the camera. For more detailed information about the installation and operation of the system monitor you should consult the monitor manuals.

Remarks:

- * When the system configuration is altered, the system monitor needs to check and memorise the cameras and accessories connected to its inputs. This is done automatically when the power is switched on (rear switch).
- * This system uses a 4 wire twisted pair telephone type cable. The use of the correct twisted pair cable can be critical to operation, especially at larger cable lengths.

Caution: Never touch the glass of the camera lens as this may cause damage.

Installation

1. Take the camera, system cable and monitor to the area you want to observe (with the monitor on site, you can check whether the camera covers the required area).



Remark: For outdoor use protective camera housing has to be used to protect the camera from rain and snow.

2. Connect the camera to the system monitor (1).
3. Connect the system monitor to the mains (2).
4. Switch on the mains power switch (3).

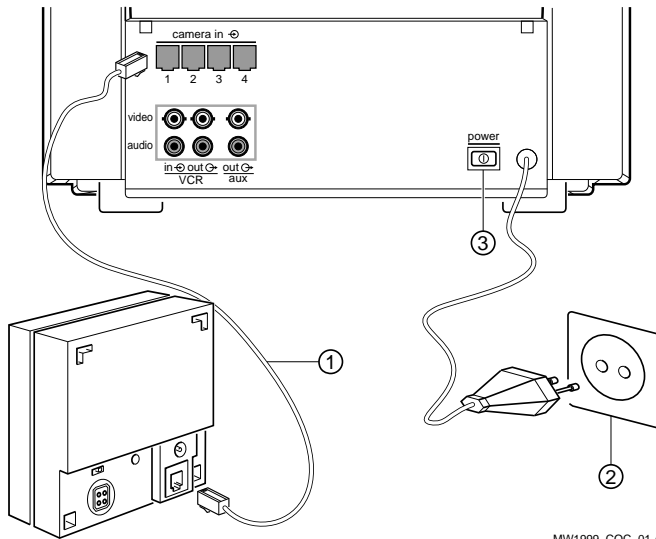
The monitor will check the system. After a short time the camera image will appear on the monitor screen.



MW1999_COC_01.AI

5. If necessary adjust contrast  /brightness  and/or colour  (controls at the front of the monitor) to optimise the camera image.
6. Hold the camera at the proposed installation position.

7. Check on the monitor whether the camera covers the required area (The best results are obtained when the camera is pointed slightly downwards and is not looking into a bright light source). Adjust focus if necessary.

8. Fasten the wall bracket (1) to the wall, or another even and firm surface.

9. Tighten the knob (2).

10. Fasten the camera to the bracket (3).

11. Loosen knob (4) and screw (5) slightly (figure below).

12. Direct the camera at the object or area you want to observe (8). Check the camera image on the monitor. Adjust focus if necessary.

13. Tighten the knob (4) and screw (5) when the camera is in position.

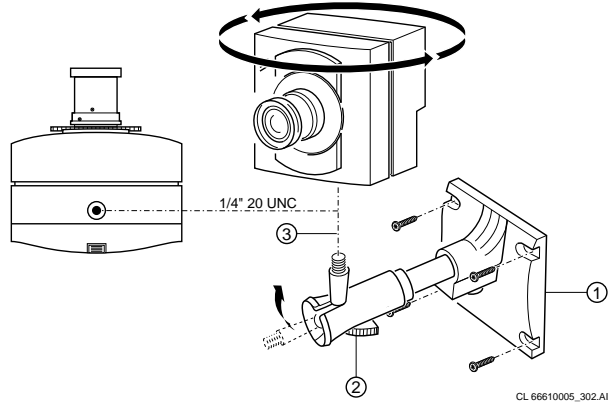

CL 66610005_302.AI

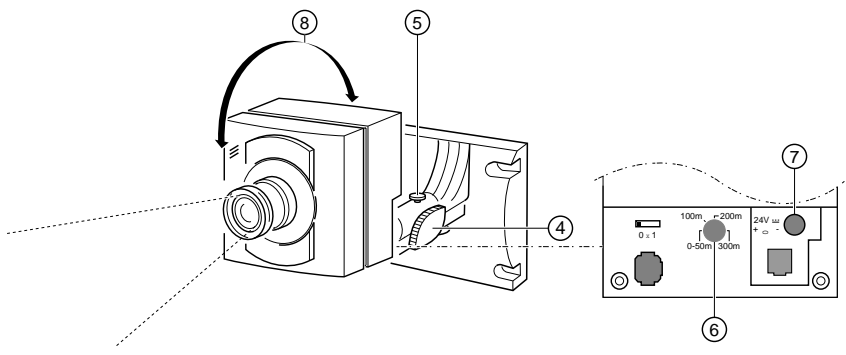

CL 66610005_303.AI

14. Check if the cable length compensation (6) selector is set to the correct length. The length set must be the same as the length of the system cable (0-300m/900ft max.) connecting monitor and camera.

Remark: If the length of the system cable is more than 200m/600ft, a mains power adapter (optional should be used (the max. cable length is 300m/900ft). Connect the adaptor to the mains and to the external supply socket (7) at the back of the camera.

Focus adjustment

- Adjust the focus ring of the camera lens to obtain optimal image sharpness.
Remark: If still no sharp object image is obtained, you should adjust the back-focus of the camera.

Back-focus adjustment

Caution: Back-focus adjustment is only necessary when no sharp object image is obtained with the focus adjustment ring.

- Set focus adjustment ring to Far or Infinity (1).
- Aim the camera at an object at least 15 metres/45 feet away.
- Remark:** When bright light sources are positioned within the camera view field; dim the light source.
- Loosen the back-focus locking ring (2).
- Rotate the lens, including the CS-mount ring, until the video image on the monitor is sharp.
- Tighten the back-focus locking ring (2), while keeping the lens in place.

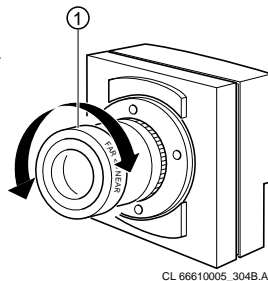

CL 66610005_304B.AI

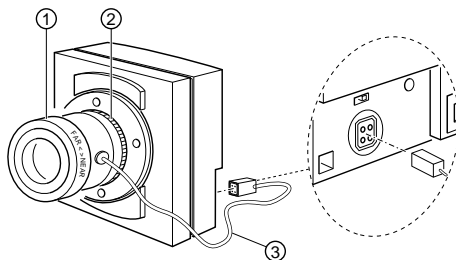

CL 66610005_305.AI

Camera sound on/off

Use switch (9) to enable or disable the built-in camera microphone.

Outdoor use

The camera switches to specific settings optimised for outdoor use when connecting an auto-iris lens.
For outdoor use a protective cover has to be used to protect the camera.
When the camera is used outdoors an auto-iris lens is recommended.

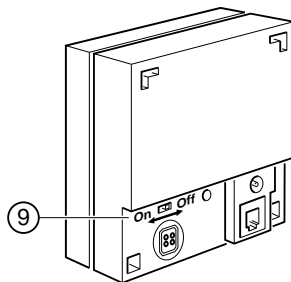

CL 66610005_306.AI

Using a different lens

The CS-mount of the camera allows you to use other lenses. The field of view (= covered area) of an 8mm lens is half of the field of view of the 4mm lens (see figure below).

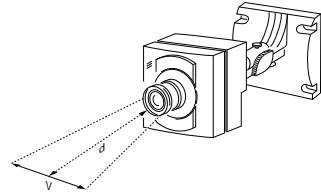

The auto-iris lenses are recommended when the camera is used in environments with variable light conditions (eg. outdoors). By means of the auto-iris the amount of light going through the lens is regulated. The auto-iris is DC-controlled through a 4-pole connector at the back of the camera (3).

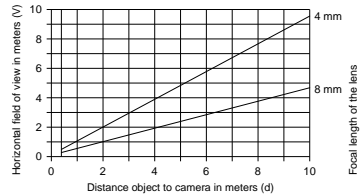

CL 66610005_308.AI

Perform the following steps to change a lens:

- Point the camera downwards. This to minimize possible deposit of dust on the inside of the camera when the lens is removed.
- Remove the old lens by turning it counter-clockwise (1). Do not release the back-focus locking ring (2), otherwise you may have to readjust the back-focus of the camera. **Caution:** Never touch the CCD sensor which is located at the inside of the camera. Only use clean, dry air to blow particles from the surface of the sensor.
- Mount the new lens by turning it clockwise onto the lens mount of the camera.

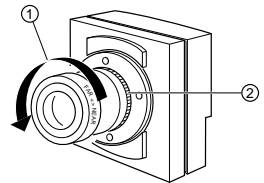

CL 66610005_312.AI

- Direct the camera at the object or area to be monitored (6).
- Tighten the knob (3) and screw (4) when the camera is in position.
- Adjust the focus ring (1) of the camera lens to obtain an optimal image sharpness. *If an auto-iris lens is used, connect the auto-iris cable to the camera (5). Switch the system on and off to setup the camera with specific outdoor settings.*

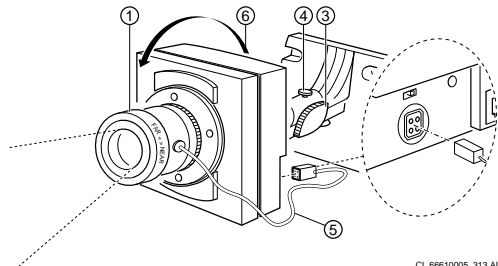

CL 66610005_313.AI

System Cable

For the interconnections between the system monitor and camera 25m/75ft system cable is supplied.

For an optimum picture and sound quality you should always use 4-wire dual twisted-pair cable when extending the connection.

The max. allowed cable length is 300m/900ft.

The cable and plugs are available in the hobby and professional trade.

Pay attention that the connectors are fixed to the cable corresponding to the figure.

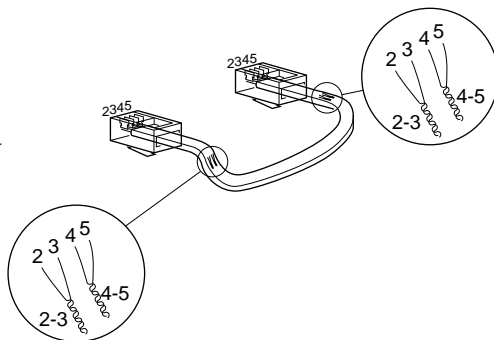

CL 66610005_006.AI

If the cable length between the monitor and camera is more than 200m/600ft a mains power adapter should be used (see accessories).

Caution: The plugs used for the observation system have the same dimensions as standard telephone plugs. Never connect a telephone to the camera or system monitor.

Tips for maintenance

Cleaning

You can clean the outside of the camera with a moist fluff-free cloth or shammy leather cloth.

When cleaning the camera lens a special cleaning cloth should be used. Do NOT use cleaning fluids based on alcohol, methylated spirit, ammonia, etc..

Never touch the glass of the camera lens to prevent its delicate coating from damaging. Avoid direct contact with water.

Technical specifications

Pick-up element	1/3" solid state CCD
Pixel elements	12 (H) x 582 (V), PAL interlaced, or 512(H) x 492 (V), NTSC interlaced
Resolution	330 TVL
Gain control	automatic
Lens	See: Using a different lens
Iris	Electronic iris When connected, an auto-iris lens overrides the electronic iris.
Light sensitivity	<ul style="list-style-type: none"> • 0.3 lux minimally acceptable picture with standard lens (F1.2) at 3200K, transmission 86%, scene reflection 100% • 0.5 lux, 50ire (-6dB) with standard lens (F1.2) at 3200K, transmission 86%, scene reflection 100%
Scene illumination	Not for continuous use above 2k lux with standard lens (F1.2) For outdoor use an auto-iris lens is recommended.
Signal to noise ratio	48dB at 200-25000 lux, 25°C
White balance TTL	range 2500-6500K
System connector (output)	RJ11E plug
Microphone	Built-in, can be switched off at the camera.
• Frequency range	300-3000Hz
Synchronisation	The camera automatically synchronises to the system monitor.
Power supply	24VDC, when the system-cable length exceeds 200m/600ft a power-adaptor (24VDC, current limit 500mA) is required (available as accessory)
Power consumption	≤3W
System-cable length	max. 300m/900ft (when a mains power adaptor is used)
Dimensions	72,5 (H) x 70 (W) x 60 (D) mm (excl. lens)
Weight	190g
Connectors	
• System cable	RJ11E modular ("telephone" plug)
• External power	Power jack
Auto-iris control	4-pole socket, passive Auto-iris, direct drive
Mounting	1/4" 20 UNC
Ambient temperature	
• Operating	-10 to +50°C
• Storage	-25 to +70°C
Ambient humidity	
• Operating	20 to 90% RH
• Storage	up to 99% RH

The pin connections of the auto-iris connector are:

- pin 1 = control coil -
- pin 2 = control coil +
- pin 3 = drive coil -
- pin 4 = drive coil +

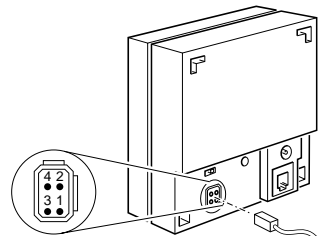

CL 66610005_309.AI